

# NUF2015W1

## USB Upstream Terminator with ESD Protection

This device is designed for applications requiring **Line Termination**, **EMI Filtering** and **ESD Protection**. It is intended for use in upstream USB ports, Cellular phones, Wireless equipment and computer applications. This device offers an integrated solution in a small package (SC-88/SOT-363) reducing PCB space and cost.

### Features:

- Provides USB Line Termination, Filtering and ESD Protection
- Single IC Offers Cost Savings
- Bidirectional EMI Filtering Prevents Noise from Entering/Leaving the System
- Compliance with IEC61000-4-2 (Level 4)
  - 8 kV (Contact)
  - 15 kV (Air)
- Flexible Pullup Line Termination to Meet USB 1.1 Low Speed and High Speed Specification
- ESD Ratings: Machine Model = C  
Human Body Model = 3B
- Pb-Free Package is Available

### Benefits:

- SC-88 Package Minimizes PCB Space
- Integrated Circuit Increases System Reliability versus Discrete Component Implementation
- TVS Devices Provide ESD Protection That is Better than a Discrete Implementation because the Small IC minimizes Parasitic Inductances

### Applications:

- USB Hubs
- Computer Peripherals Using USB

### MAXIMUM RATINGS ( $T_A = 25^\circ\text{C}$ )

Rating	Symbol	Value	Unit
Steady State Power	$P_D$	225	mW
Maximum Junction Temperature	$T_{J(\max)}$	125	$^\circ\text{C}$
Operating Temperature Range	$T_J$	-55 to +125	$^\circ\text{C}$
Storage Temperature Range	$T_{\text{stg}}$	-55 to +125	$^\circ\text{C}$
Lead Solder Temperature (10 second duration)	$T_L$	260	$^\circ\text{C}$

Stresses exceeding Maximum Ratings may damage the device. Maximum Ratings are stress ratings only. Functional operation above the Recommended Operating Conditions is not implied. Extended exposure to stresses above the Recommended Operating Conditions may affect device reliability.



**ON Semiconductor®**

<http://onsemi.com>

### CIRCUIT DESCRIPTION

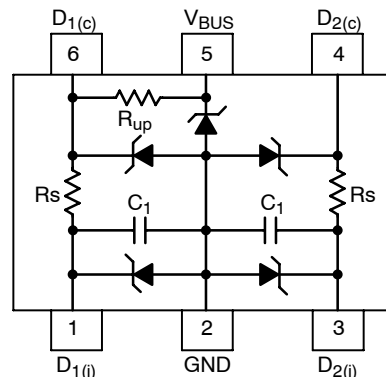

### MARKING DIAGRAM

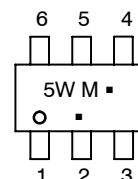
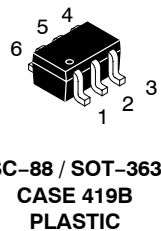

- 5W = Specific Device Code
- M = Date Code
- = Pb-Free Package

(Note: Microdot may be in either location)

### ORDERING INFORMATION

Device	$R_s$ ( $\Omega$ )	Pkg.	Shipping†
NUF2015W1T2	15	SC-88	3000/Tape & Reel
NUF2015W1T2G	15	SC-88 (Pb-Free)	3000/Tape & Reel

†For information on tape and reel specifications, including part orientation and tape sizes, please refer to our Tape and Reel Packaging Specification Brochure, BRD8011/D.

# NUF2015W1

## ELECTRICAL CHARACTERISTICS (T<sub>A</sub> = 25°C unless otherwise noted)

Device	V <sub>RWM</sub> (V)	V <sub>BR</sub> @ 1 mA (V)			I <sub>R</sub> @ 3.3 V (nA)			Line Capacitance V <sub>dc</sub> = 2.5 V f = 1 MHz (pF) (Note 1)			Series Resistor R <sub>S</sub> (Ω)			Pullup Resistor R <sub>UP</sub> (kΩ)		
		Min	Typ	Max	Min	Typ	Max	Min	Typ	Max	Min	Typ	Max	Min	Typ	Max
NUF2015W1T2	5.25	5.6	6.8	8.0	-	10	100	33	42	51	12	15	18	1.2	1.5	1.8

1. Measured between Pins 1, 3, 4, 6 and ground with Pin 5 also grounded.
2. For other resistance values (e.g. 15 Ω, 33 Ω), please contact your local ON Semiconductor sales representative.

## TYPICAL CHARACTERISTICS

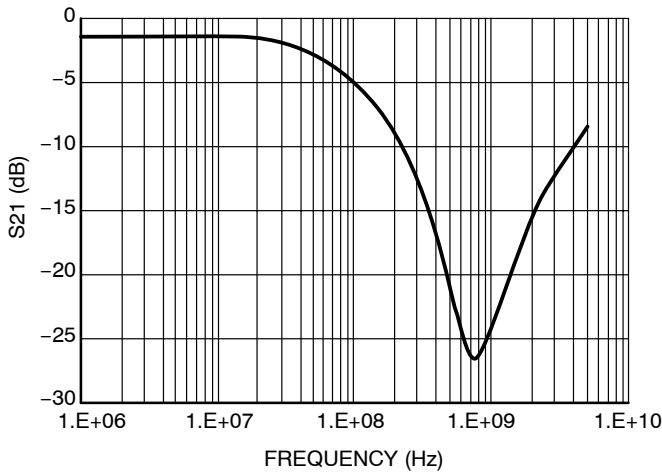

Figure 1. Insertion Loss Characteristics (S21 Measurement)

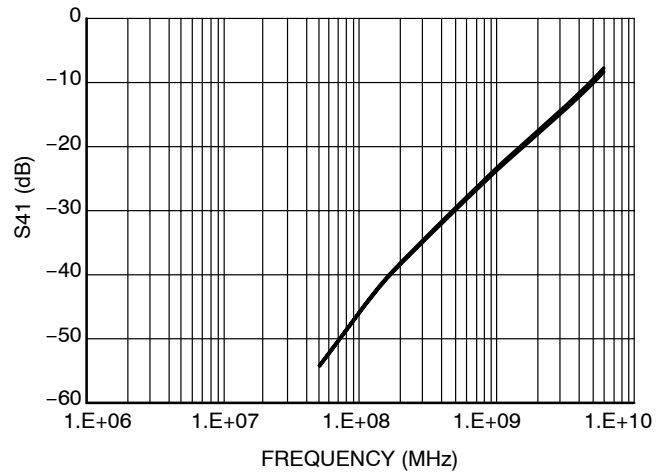

Figure 2. Analog Cross-Talk (S41 Measurement)

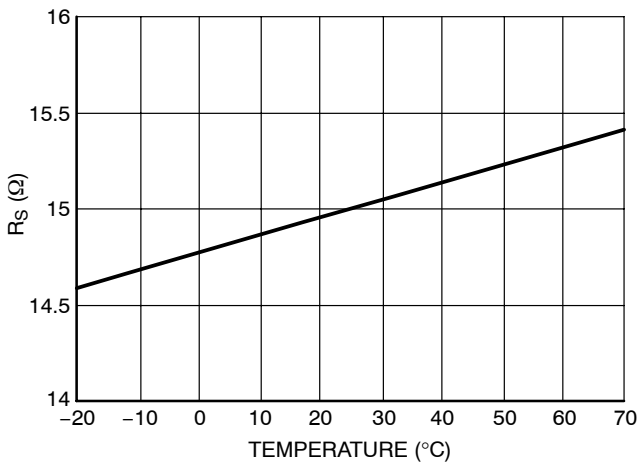

Figure 3. R<sub>S</sub> vs. Temperature

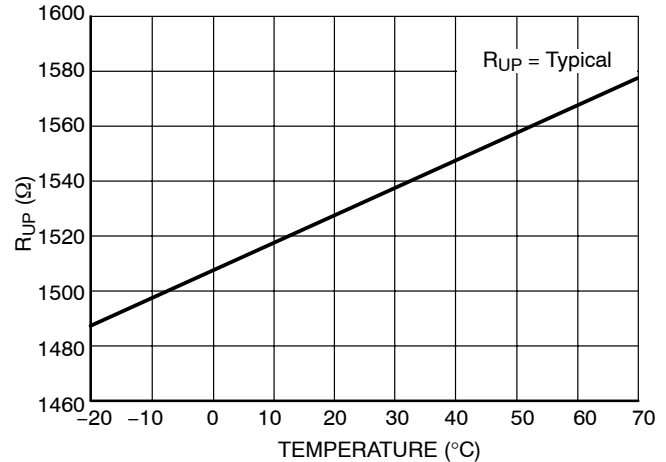

Figure 4. R<sub>UP</sub> vs. Temperature

## APPLICATIONS BACKGROUND

### What is USB?

The USB is not a serial port, it is a serial bus, a fact that enables a single port on the computer to be a link for a myriad of devices, (up to 127 devices in a USB system). We can easily chain one device to another and use one port as a connecting point of many devices by using a hub. All these enable us to look at the USB system as a small network of devices.

The Universal Serial Bus (USB) makes connecting devices to your computer faster, easier and virtually limitless. High-Speed USB devices are capable of communicating at speeds up to 12 megabytes—without shutting down and without having to open your computer.

### Typical USB System

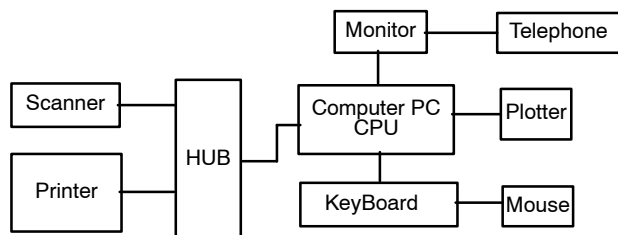

Figure 5. Typical USB System

Typically the USB system consists of one host, hubs and devices.

### The Host

The host in the USB system, is responsible to the whole complexity of the protocol (simplifies the designing of USB devices). The host controls the media access, therefore, no one can access the bus unless it got an approval required from the host.

### The Hub

The hub provides an interconnect point, which enables many devices to connect to a single USB port. The logical topology of the USB is a star structure, all the devices are connected (logically) directly to the host. It is totally transparent to the device what is its' hub tier (the number of hubs the data has to flow through). The hub is connected to the USB host in the upstream direction (data flows "up" to the host) and is connected to the USB device in the downstream direction (data flows "down" from the host to the device). The hubs' main functionality is the responsibility of detecting an attachment and detachment of

devices, handling the power management for devices that are bus-powered (get power from the bus), and responsibility for bus error detection and recovery. Another important role of the hub is to manage both full and low speed devices. When a device is attached to the system the hub detects the speed, which the device operates in, and through the whole communication on the bus prevents from full speed traffic to reach low speed device and vice versa – prevent from low speed traffic to reach full speed device.

### The Device

The device is defined as everything in the USB system, which is not a host (including hubs). A device provides one or more USB functions. Most of the devices provide only one function but there may be some, which provides more than one and called compound devices. We refer to two kinds of devices – self powered or bus powered devices. A device that gets its power from the bus is called bus powered and on the other hand a device which supplies its own power is called self powered. There are two kinds of devices for USB 1.1:

Full-speed devices – operates in 12 Mb/s

Low-speed devices that work in 1.5 Mb/s.

### NUF2015W1T2 Device Information

The Universal Serial Bus (USB) specification revision 1.1 requires the USB drivers to have certain impedance characteristics. The series resistance plus the USB driver output resistance must be close to the USB cable's impedance of  $45\ \Omega$  unbalanced ( $90\ \Omega$  balance) to minimize transmission line reflections. In addition USB 1.1 also requires upstream ports to be terminated with a pullup resistor (usually  $1.5\ \text{k}\Omega$ ) from D+ or D- lines to  $V_{CC} = 3.3\ \text{V}$  ( $V_{CC}$  is usually taken from  $V_{BUS}$  by using a  $5\ \text{V} - 3.3\ \text{V}$  regulator). In case of EMI, the radiated and conducted EMI should be kept within the required levels as specified by the FCC regulations. Actual FCC regulations requires that class B computing devices meet the specifications of maximum levels for both radiated and conducted EMI (Radiated EMI covers the frequency range from 30 MHz to 1 GHz and Conducted EMI covers the 450 kHz to 30MHz range).

The NUF2015W1T2 device from On Semiconductor provides series termination, EMI filtering and ESD protection for the two data lines (D+, D-) as well as for the VBUS. The ESD device's ratings comply with IEC61000-4-2 (Level 4), HBM class 3B and MM class C. All these features are offered in an integrated solution placed in a small and single package (SC-88, Case 419B). The NUF2015W1T2 device is shown in the Figure 6.

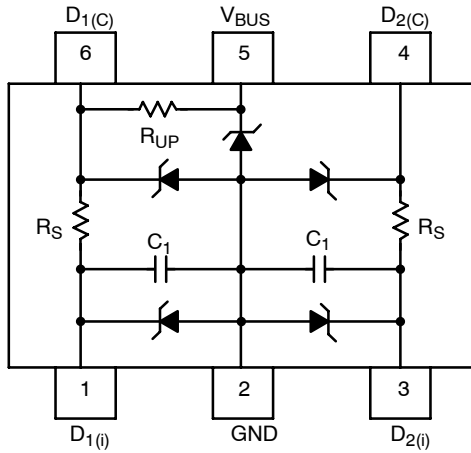

Figure 6. Device Description

**Connection for Full-Speed and Low-Speed Devices**

The USB 1.1 specification calls for two data rates:

- Full-speed devices – operates in 12 Mb/s
- Low-speed devices that work in 1.5 Mb/s.

The NUF2015W1T2 device can be shaped for either full-speed or low-speed by connecting one of the data lines (D+, D-) to a 3.3 V voltage supply through the 1.5 kΩ pullup resistor. The device’s connection diagrams for each speed are described as follows:

**Full-Speed Connection**

The pullup resistor ( $R_{UP}$ ) is connected to the D+ line. The terminal 5 is connected to a 3.3 V voltage supply while the terminal 2 is connected to ground. The input of the D+ line is connected in the terminal 1 which outputs from the terminal 6. Finally, the input of the D- line is connected in the terminal 3 which outputs from the terminal 4. Figure 7 shows the connections of the NUF2015W1T2 device for “Full-Speed”.

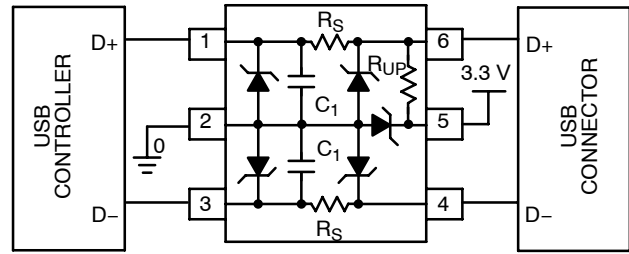

Figure 7. Full Speed Connection

**Low-Speed Connection**

The pullup resistor ( $R_{pu}$ ) is connected to the D- line. The terminal 5 is connected to a 3.3 V voltage supply while the terminal 2 is connected to ground. The input of the D- line is connected in the terminal 1 which outputs from the terminal 6. Finally, the input of the D+ line is connected in the terminal 3 which outputs from the terminal 4. The Figure 8 shows the connections of the NUF2015W1T2 device for “Low-Speed”.

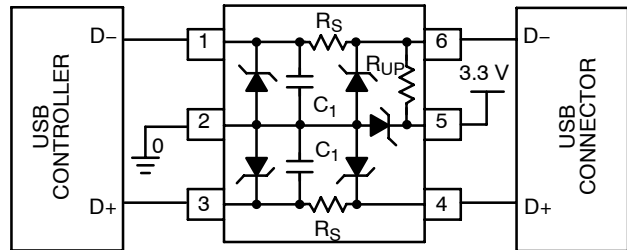
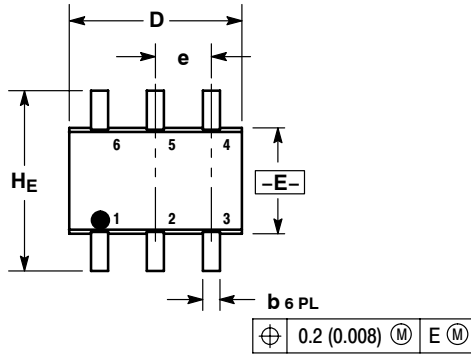

Figure 8. Low Speed Connection

# NUF2015W1

## PACKAGE DIMENSIONS

SC-88/SC70-6/SOT-363  
CASE 419B-02  
ISSUE W



- NOTES:
1. DIMENSIONING AND TOLERANCING PER ANSI Y14.5M, 1982.
  2. CONTROLLING DIMENSION: INCH.
  3. 419B-01 OBSOLETE, NEW STANDARD 419B-02.

DIM	MILLIMETERS			INCHES		
	MIN	NOM	MAX	MIN	NOM	MAX
A	0.80	0.95	1.10	0.031	0.037	0.043
A1	0.00	0.05	0.10	0.000	0.002	0.004
A3	0.20 REF			0.008 REF		
b	0.10	0.21	0.30	0.004	0.008	0.012
C	0.10	0.14	0.25	0.004	0.005	0.010
D	1.80	2.00	2.20	0.070	0.078	0.086
E	1.15	1.25	1.35	0.045	0.049	0.053
e	0.65 BSC			0.026 BSC		
L	0.10	0.20	0.30	0.004	0.008	0.012
HE	2.00	2.10	2.20	0.078	0.082	0.086

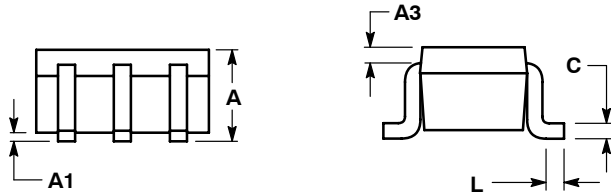

### SOLDERING FOOTPRINT\*

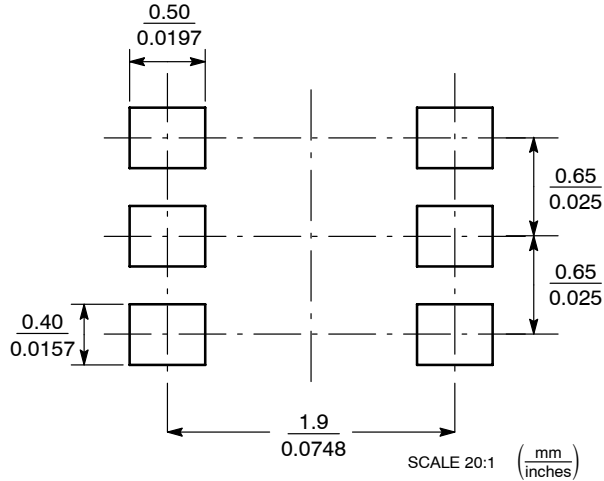

### SC-88/SC70-6/SOT-363

\*For additional information on our Pb-Free strategy and soldering details, please download the ON Semiconductor Soldering and Mounting Techniques Reference Manual, SOLDERRM/D.

**ON Semiconductor** and  are registered trademarks of Semiconductor Components Industries, LLC (SCILLC). SCILLC reserves the right to make changes without further notice to any products herein. SCILLC makes no warranty, representation or guarantee regarding the suitability of its products for any particular purpose, nor does SCILLC assume any liability arising out of the application or use of any product or circuit, and specifically disclaims any and all liability, including without limitation special, consequential or incidental damages. "Typical" parameters which may be provided in SCILLC data sheets and/or specifications can and do vary in different applications and actual performance may vary over time. All operating parameters, including "Typicals" must be validated for each customer application by customer's technical experts. SCILLC does not convey any license under its patent rights nor the rights of others. SCILLC products are not designed, intended, or authorized for use as components in systems intended for surgical implant into the body, or other applications intended to support or sustain life, or for any other application in which the failure of the SCILLC product could create a situation where personal injury or death may occur. Should Buyer purchase or use SCILLC products for any such unintended or unauthorized application, Buyer shall indemnify and hold SCILLC and its officers, employees, subsidiaries, affiliates, and distributors harmless against all claims, costs, damages, and expenses, and reasonable attorney fees arising out of, directly or indirectly, any claim of personal injury or death associated with such unintended or unauthorized use, even if such claim alleges that SCILLC was negligent regarding the design or manufacture of the part. SCILLC is an Equal Opportunity/Affirmative Action Employer. This literature is subject to all applicable copyright laws and is not for resale in any manner.

## PUBLICATION ORDERING INFORMATION

### LITERATURE FULFILLMENT:

Literature Distribution Center for ON Semiconductor  
P.O. Box 61312, Phoenix, Arizona 85082-1312 USA  
**Phone:** 480-829-7710 or 800-344-3860 Toll Free USA/Canada  
**Fax:** 480-829-7709 or 800-344-3867 Toll Free USA/Canada  
**Email:** [orderlit@onsemi.com](mailto:orderlit@onsemi.com)

**N. American Technical Support:** 800-282-9855 Toll Free  
USA/Canada

**Japan:** ON Semiconductor, Japan Customer Focus Center  
2-9-1 Kamimeguro, Meguro-ku, Tokyo, Japan 153-0051  
**Phone:** 81-3-5773-3850

**ON Semiconductor Website:** <http://onsemi.com>

**Order Literature:** <http://www.onsemi.com/litorder>

For additional information, please contact your  
local Sales Representative.